

PLANTA BAIXA - DET 02
ESC. 1:50

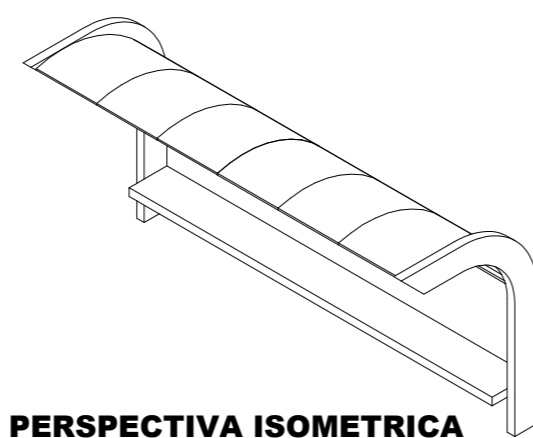

PERSPECTIVA ISOMETRICA
ESC. 1:50

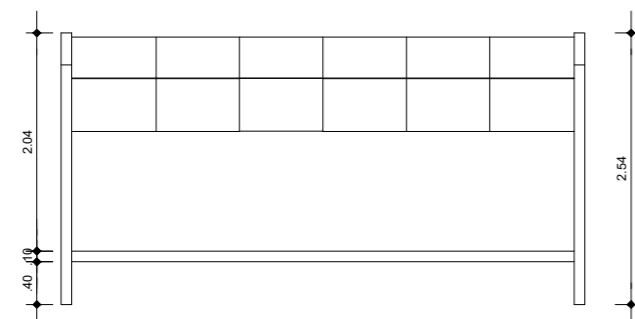

ELEVAÇÃO 1 - DET 02
ESC. 1:50

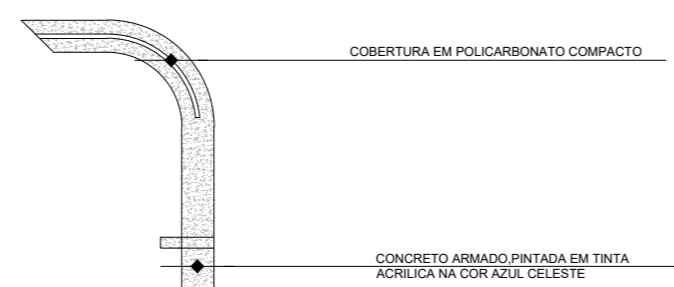

SECÇÃO A - DET 02
ESC. 1:50

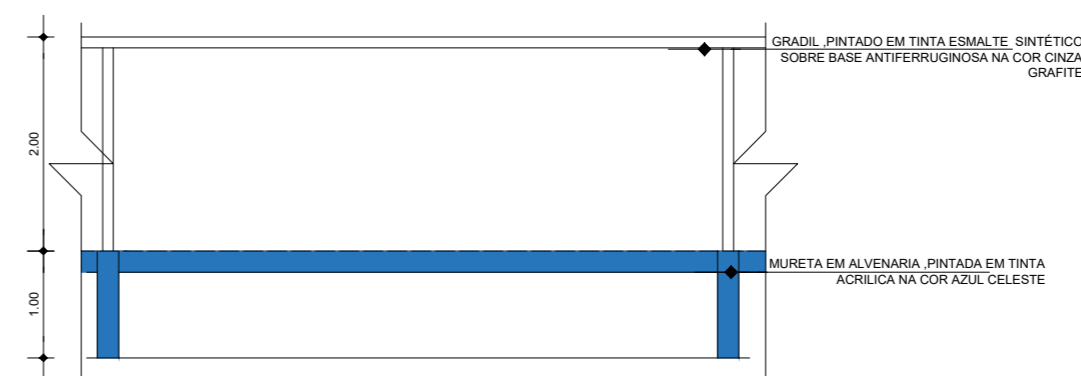

DET 01
ESC. 1:50

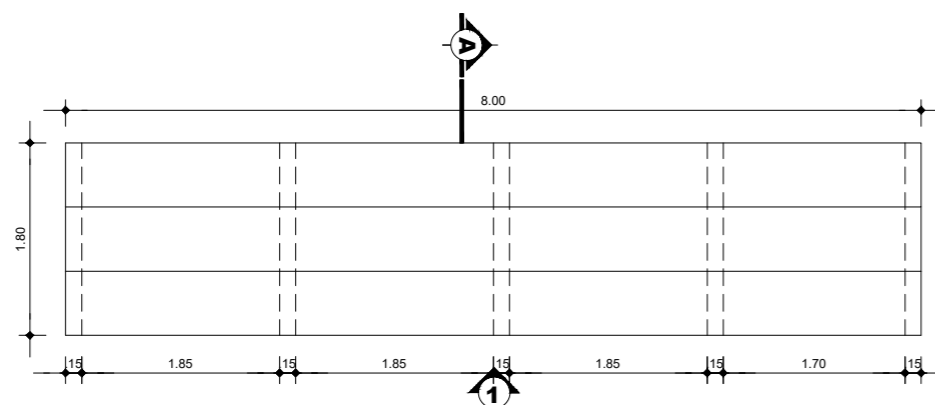

PLANTA BAIXA - DET 03
ESC. 1:50

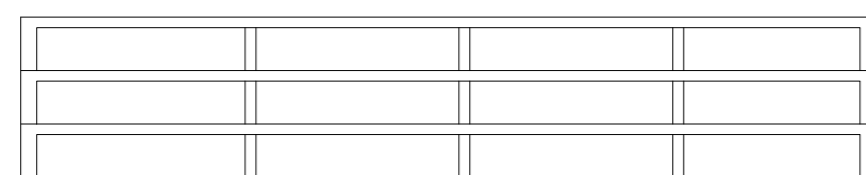

ELEVAÇÃO 1 - 03
ESC. 1:50

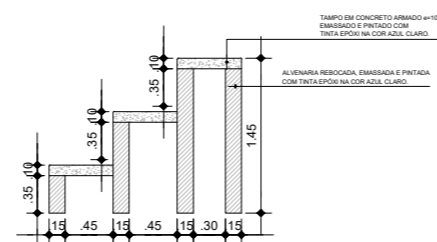

SECÇÃO A - 03
ESC. 1:50



PREFEITURA MUNICIPAL DE ANANINDEUA
SECRETARIA DE SANEAMENTO E INFRA-ESTRUTURA

CAMPO DO URUBU
REFORMA CAMPO DO URUBU – RUA TREZE DE MAIO – MAGUARI, ANANINDEUA – PA
ESTRADA DO CURUÇAMBÁ OESTE S/N

DATA:
AGOSTO/2022
ESC.:
1:50
RESP. TÉCNICO:
DEP. PROJETOS

CONTEÚDO:
DET 01, 02, 03
TRECHO 01/03
TRECHO 02/03
TRECHO 03/03

05-05

Travessa WE 17, s/n – Conj. Cidade Nova IV,
em frente ao Supermercado Formosa
Coqueira-Ananindeua-Pará – Fone: (91) 3344-2050