

**ÁREA DE CONVIVENCIA-ATENDIMENTO AO EMPREENDEDOR**  
ESC. 1:100

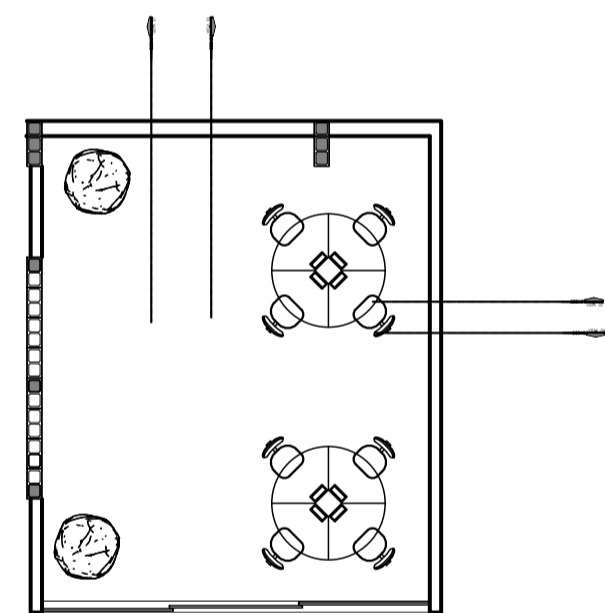

**SALA DE TREINAMNETO**  
ESC. 1:100

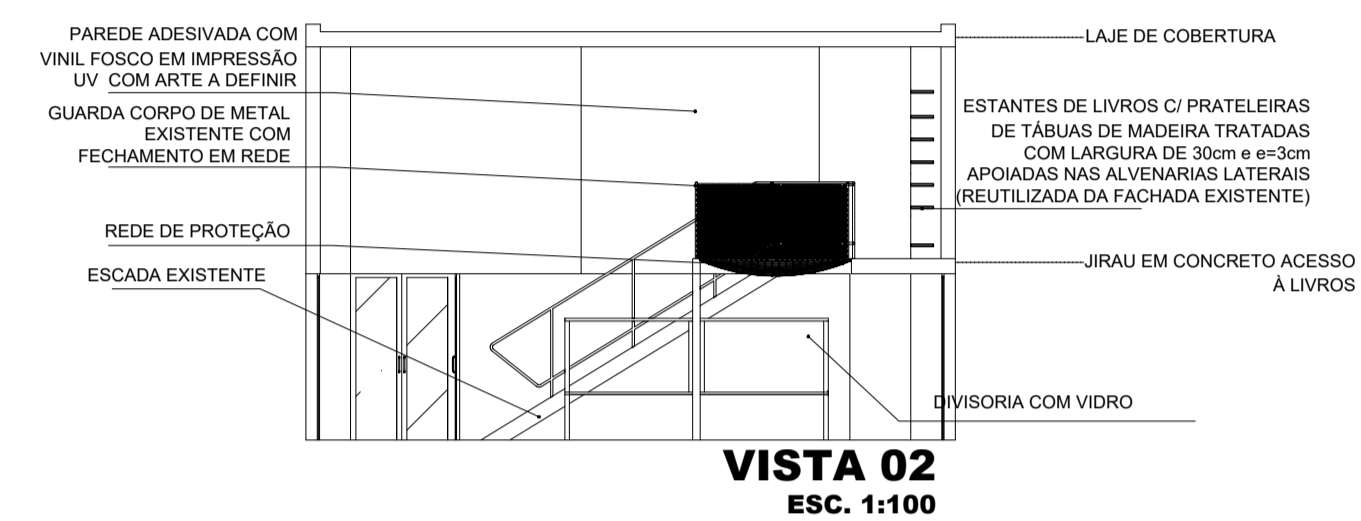
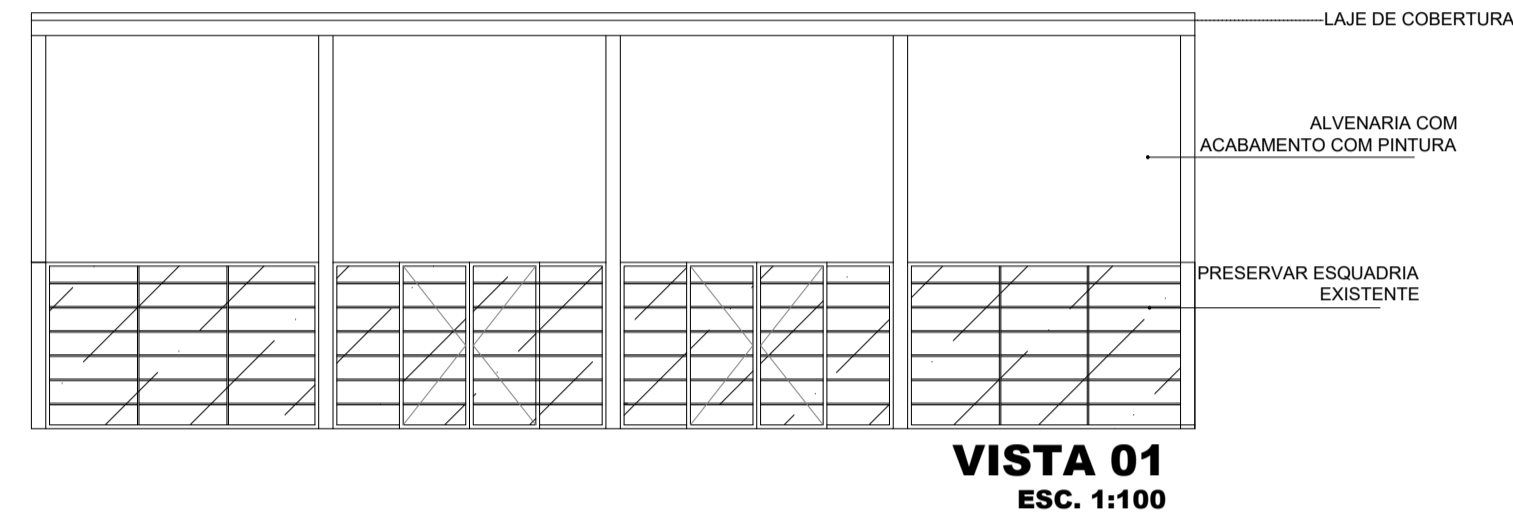
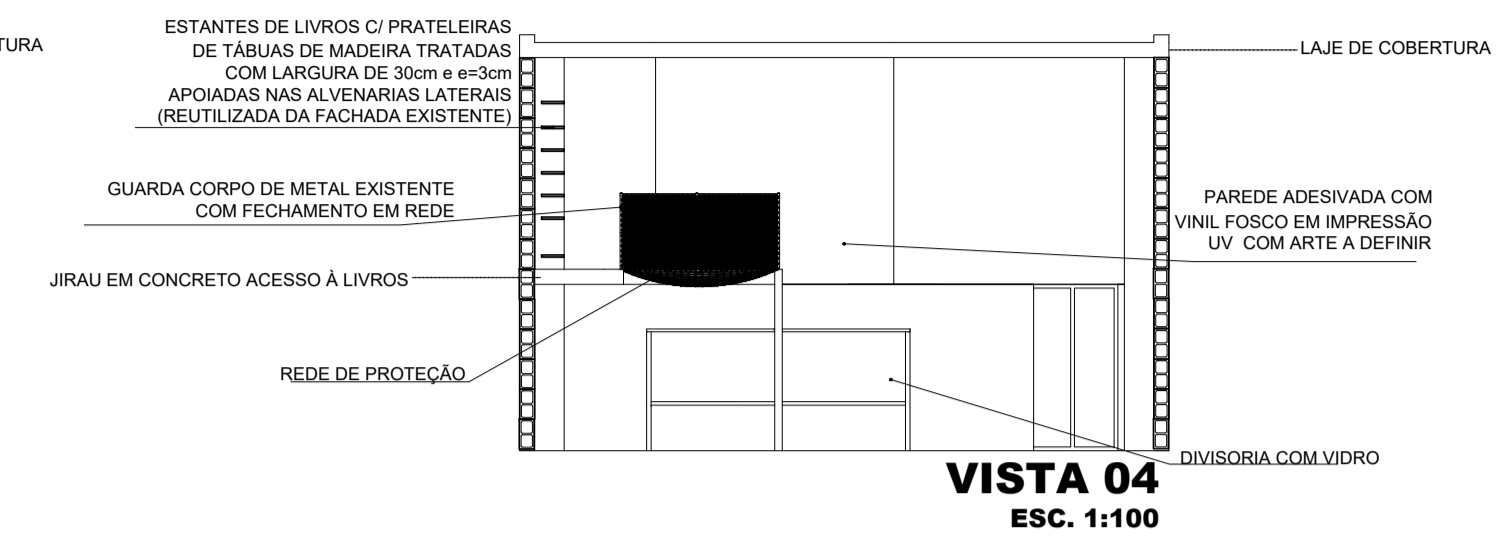
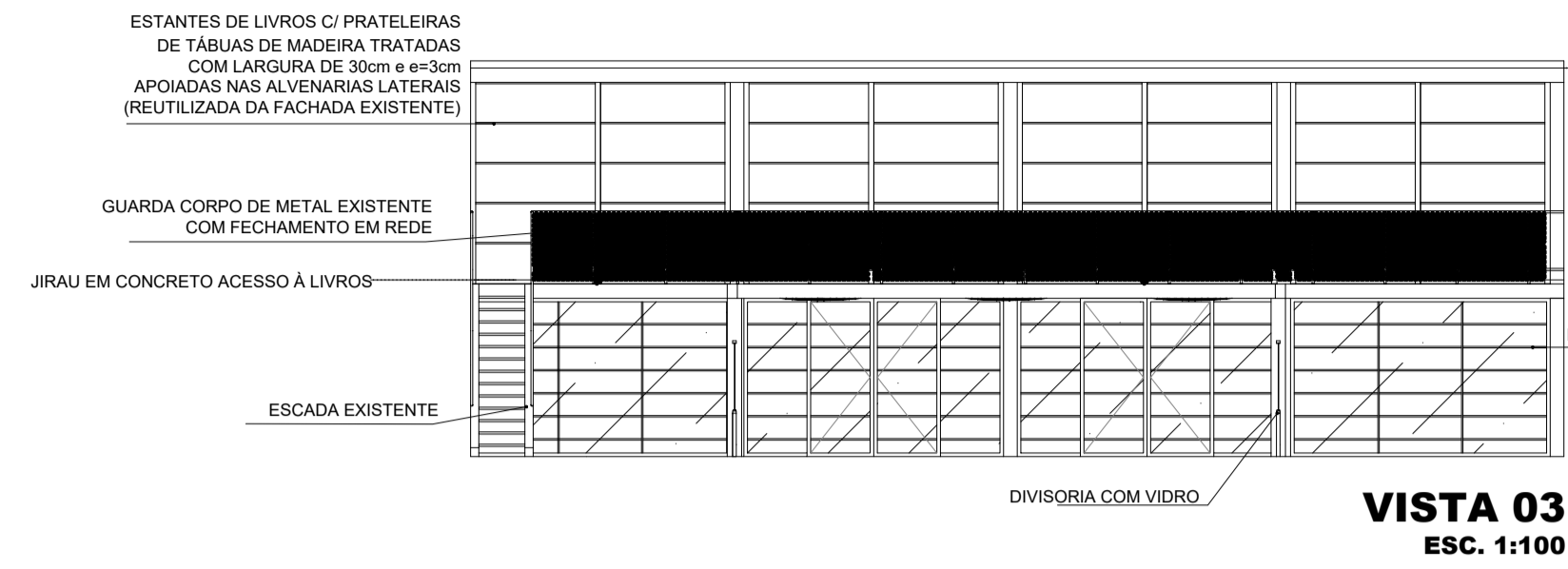
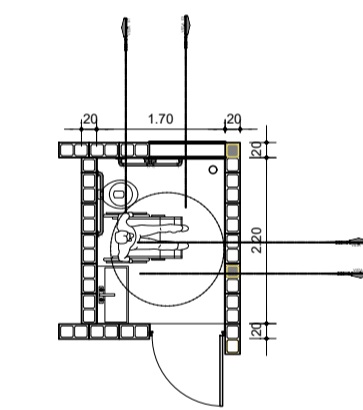
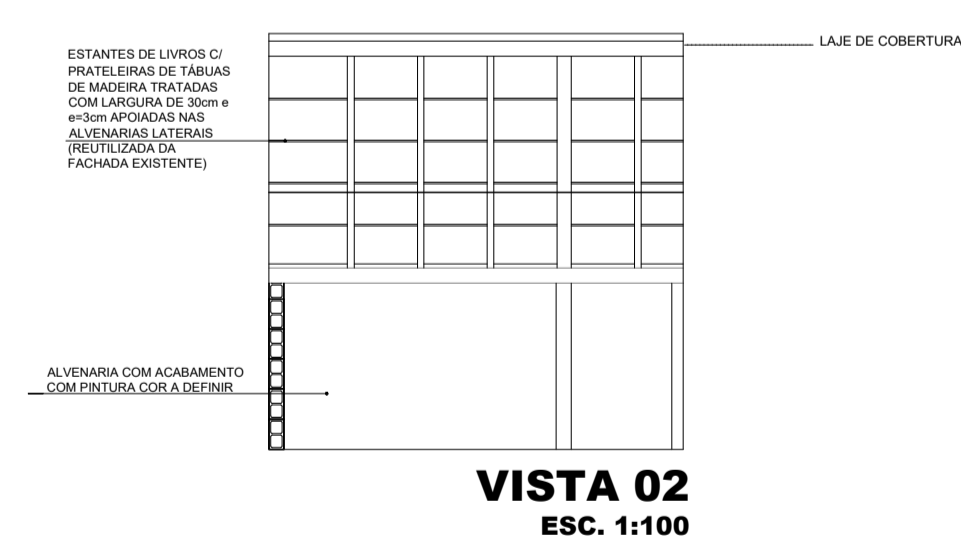
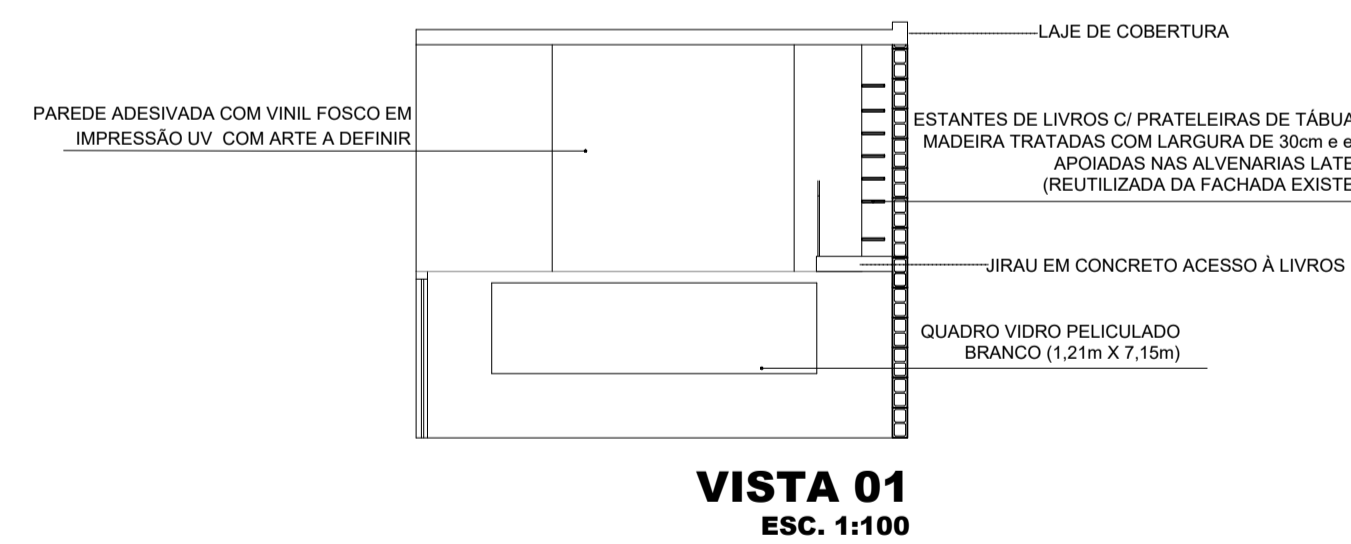
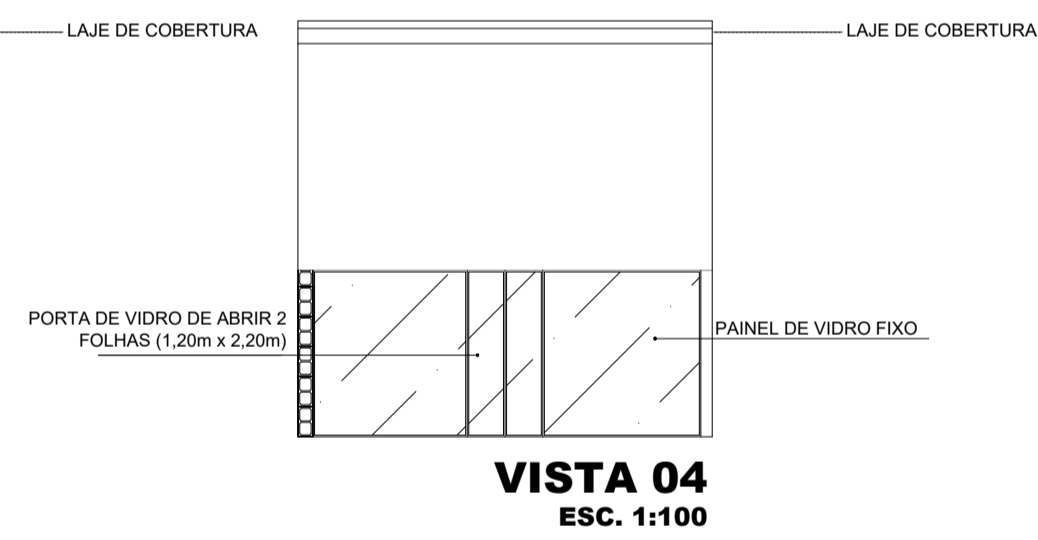
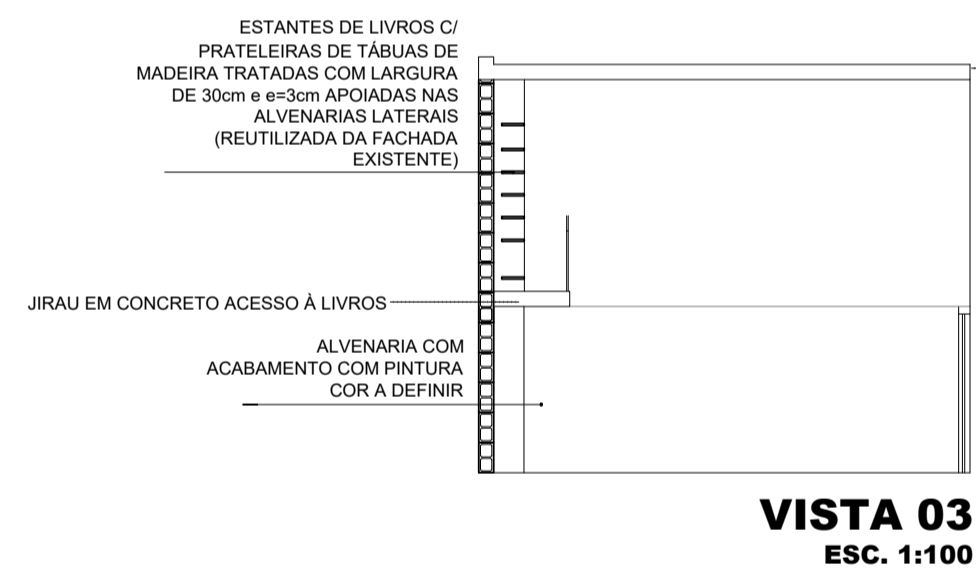

**BANHEIRO TIPO**  
ESC. 1:100

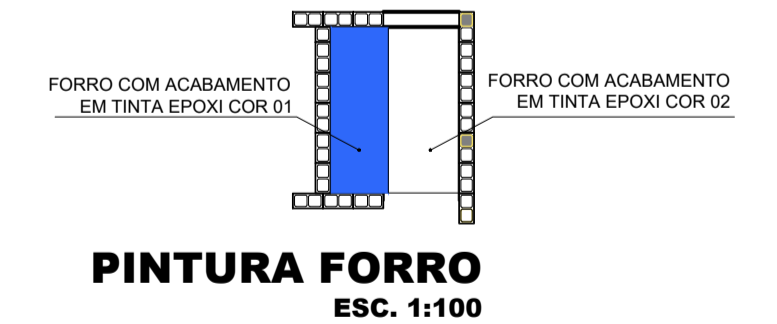
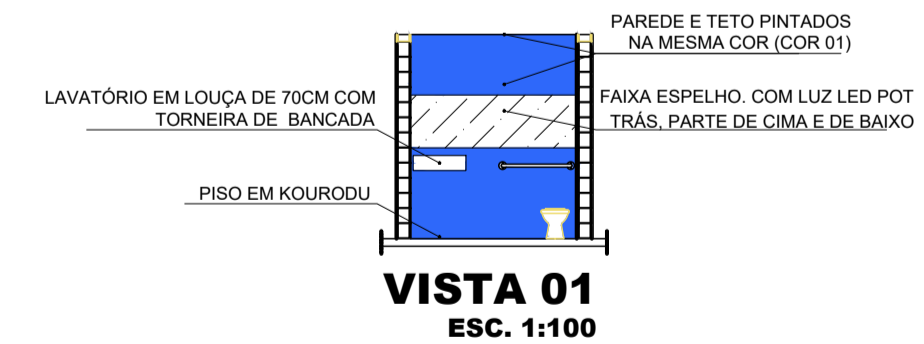
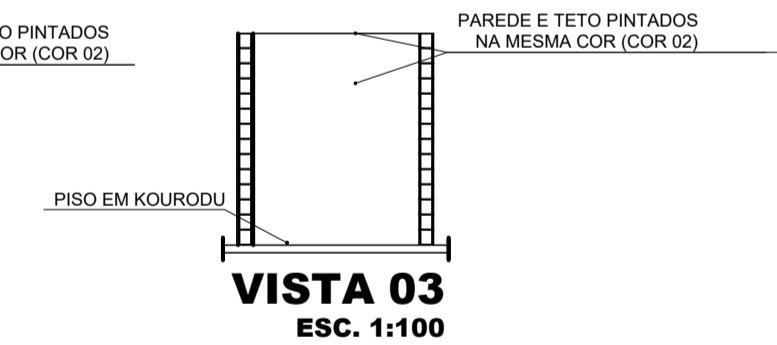
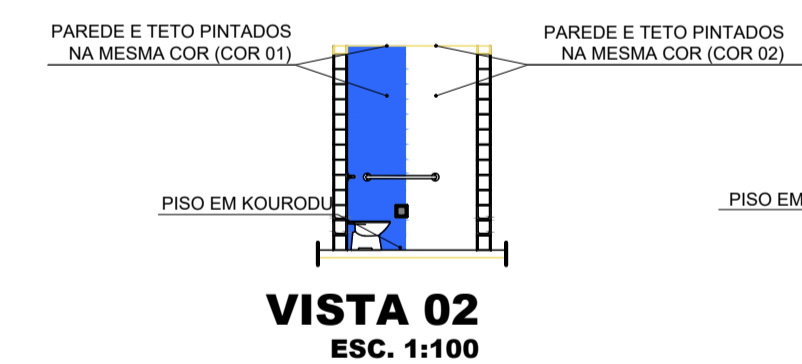
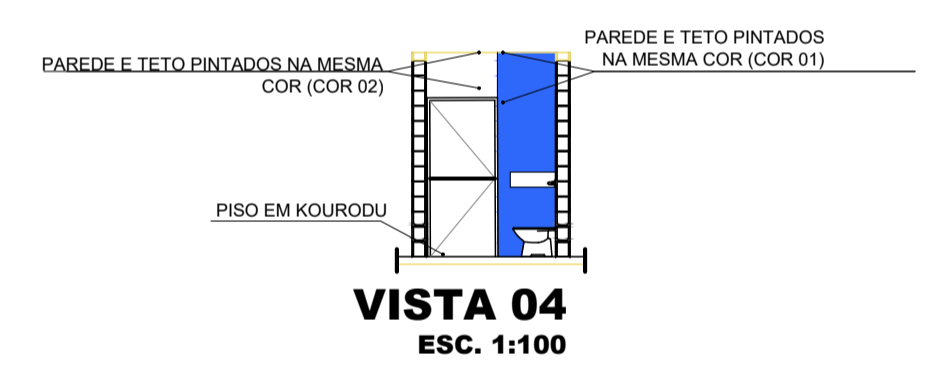

**PREFEITURA MUNICIPAL DE ANANINDEUA**  
**SECRETARIA DE SANEAMENTO E INFRA-ESTRUTURA**  
CONSTRUÇÃO DO POLO CRIATIVO DIGITAL  
PROJETO EXECUTIVO DE ARQUITETURA  
AV. ARTERIAL 5 - A S/N

DATA: FEVEREIRO/2023  
ESC.: 1:100  
RESP. TÉCNICO: DEPT. PROJETOS

CONTEÚDO: ELEVACÃO  
ÁREA CONVIVENCIA, SALA DE TREINAMENTO E BANHEIRO